

Multilayer Chip Inductors

FEATURES

- Internal printed coil structure creates a closed magnetic circuit which acts as a magnetic shield eliminating cross talk, thus permitting higher mounting densities.
- Multilayer block structure yields higher reliability.

RECOMMENDED APPLICATIONS

- Any general circuit of portable equipment which compact size and high mounting densities are required.

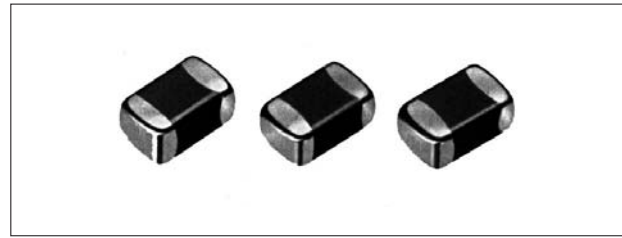

Operating Temperature: -40~85°C

EXTERNAL DIMENSIONS

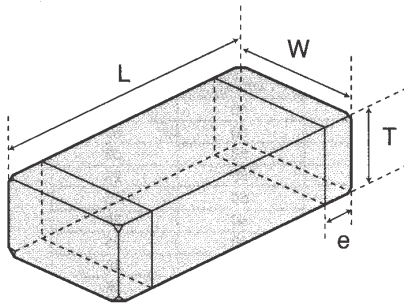

Type	L	W	T	e
GLF1608 (0603)	1.6±0.15 (0.063±0.006)	0.8±0.15 (0.031±0.006)	0.8±0.15 (0.031±0.006)	0.3±0.2 (0.012±0.008)
GLF2125 (0805)	2.0 ^{+0.3} _{-0.1} (0.079 ^{+0.012} _{-0.004})	1.25±0.2 (.049±0.008)	0.85±0.2 1.25±0.2 (0.033±0.008) (0.049±0.008)	0.5±0.3 (0.020±0.012)
GLF3216 (1206)	3.2±0.2 (0.126±0.008)	1.6±0.2 (0.063±0.008)	0.6±0.2 1.1±0.3 (0.024±0.008) (0.043±.012)	0.5±0.3 (0.020±0.012)

Inductance	I _{max} [mA]	R _{dcmax} [Ω]	I _{max} [mA]	R _{dcmax} [Ω]	I _{max} [mA]	R _{dcmax} [Ω]
0.1μH	50	0.50	250	0.30	250	0.25
1μH	25	0.60	50	0.40	100	0.40
10μH	5	2.55	15	1.15	25	1.00

ORDERING CODE

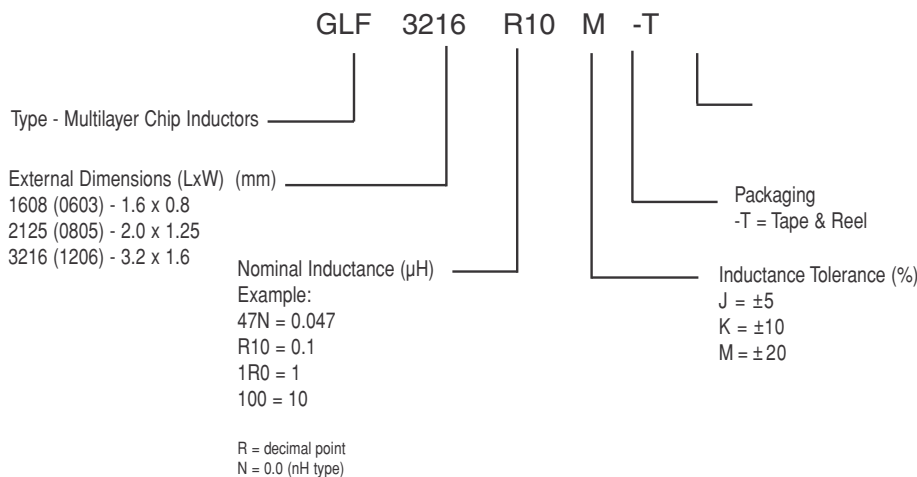

Multilayer Chip Inductors - GLF1608

Part No.	Inductance (μH)	Inductance Tolerance	Q (min.)	Self Resonant frequency [MHz] (min.)	DC Resistance [Ω] (max.)	Related Current [mA] (max.)	Measuring Frequency [MHz]	Thickness [mm] (inch)	
GLF1608 47NM□	0.047	±5%	10	260	0.30	50	50	0.8±0.15 (0.031±0.006)	
GLF1608 68NM□	0.068	±10%	10	250	0.30	50	50		
GLF1608 82NM□	0.082	±20%	10	245	0.30	50	50		
GLF1608 R10□	0.10	±5%	15	240	0.50	50	25		
GLF1608 R12□	0.12		15	205	0.50	50	25		
GLF1608 R15□	0.15		±10%	15	180	0.60	50		25
GLF1608 R18□	0.18	±20%	15	165	0.60	50	25		
GLF1608 R22□	0.22	±10%	15	150	0.80	50	25		
GLF1608 R27□	0.27		15	136	0.80	50	25		
GLF1608 R33□	0.33		15	125	0.85	35	25		
GLF1608 R39□	0.39		15	110	1.00	35	25		
GLF1608 R47□	0.47		15	105	1.35	35	25		
GLF1608 R56□	0.56		15	95	1.55	35	25		
GLF1608 R68□	0.68		15	80	1.70	35	25		
GLF1608 R82□	0.82		15	75	2.10	35	25		
GLF1608 1R0□	1.0		35	70	0.60	25	10		
GLF1608 1R2□	1.2		35	60	0.80	25	10		
GLF1608 1R5□	1.5		35	55	0.80	25	10		
GLF1608 1R8□	1.8		35	50	0.95	25	10		
GLF1608 2R2□	2.2		35	45	1.15	15	10		
GLF1608 2R7□	2.7		35	40	1.35	15	10		
GLF1608 3R3□	3.3		35	38	1.55	15	10		
GLF1608 3R9□	3.9	35	36	1.70	15	10			
GLF1608 4R7□	4.7	35	33	2.10	15	10			
GLF1608 5R6□	5.6	35	22	1.55	5	4			
GLF1608 6R8□	6.8	35	20	1.70	5	4			
GLF1608 8R2□	8.2	35	18	2.10	5	4			
GLF1608 100□	10	35	17	2.55	5	2			
GLF1608 120□	12	35	15	2.75	5	2			
GLF1608 150M□	15	±10%	20	14	1.70	1	1		
GLF1608 180M□	18		20	13	1.85	1	1		
GLF1608 220M□	22		±20%	20	11	2.10	1		1
GLF1608 270M□	27		20	10	2.75	1	1		
GLF1608 330M□	33		20	9	2.95	1	1		

□ Please specify the Inductance Tolerance Code (J, K, or M).

Note: Values from .0012μH to .039μH are available please consult factory.

Multilayer Chip Inductors - GLF2125

Part No.	Inductance (μH)	Inductance Tolerance	Q (min.)	Self Resonant frequency [MHz] (min.)	DC Resistance [Ω] (max.)	Related Current [mA] (max.)	Measuring Frequency [MHz]	Thickness [mm] (inch)	
GLF2125 47NM□	0.047	±5%	15	320	0.20	300	50	0.85±0.2 (0.033±0.008)	
GLF2125 68NM□	0.068	±10%	15	280	0.20	300	50		
GLF2125 82NM□	0.082	±20%	15	255	0.20	300	50		
GLF2125 R10□	0.10	±5%	20	235	0.30	250	25		
GLF2125 R12□	0.12		20	220	0.30	250	25		
GLF2125 R15□	0.15		20	200	0.40	250	25		
GLF2125 R18□	0.18		20	185	0.40	250	25		
GLF2125 R22□	0.22		±10%	20	170	0.50	250		25
GLF2125 R27□	0.27		±20%	20	150	0.50	250		25
GLF2125 R33□	0.33		20	145	0.55	250	25		
GLF2125 R39□	0.39		25	135	0.65	200	25		
GLF2125 R47□	0.47		25	125	0.65	200	25		
GLF2125 R56□	0.56		±10%	25	115	0.75	150	25	1.25±0.2 (0.049±0.008)
GLF2125 R68□	0.68	25		105	0.80	150	25		
GLF2125 R82□	0.82	25		100	1.00	150	25		
GLF2125 1R0□	1.0	±20%		45	75	0.40	50	10	0.85±0.2 (0.033±0.008)
GLF2125 1R2□	1.2			45	65	0.50	50	10	
GLF2125 1R5□	1.5			45	60	0.50	50	10	
GLF2125 1R8□	1.8			45	55	0.60	50	10	
GLF2125 2R2□	2.2			45	50	0.65	30	10	
GLF2125 2R7□	2.7			45	45	0.75	30	10	
GLF2125 3R3□	3.3			45	41	0.80	30	10	
GLF2125 3R9□	3.9		45	38	0.90	30	10		
GLF2125 4R7□	4.7		45	35	1.00	30	10		
GLF2125 5R6□	5.6		±10%	50	32	0.90	15	4	
GLF2125 6R8□	6.8	50		29	1.00	15	4		
GLF2125 8R2□	8.2	50		26	1.10	15	4		
GLF2125 100□	10	50		24	1.15	15	2		
GLF2125 120□	12	50		22	1.25	15	2		
GLF2125 150M□	15	±20%		30	19	0.80	5	1	
GLF2125 180M□	18			30	18	0.90	5	1	
GLF2125 220M□	22			30	16	1.10	5	1	
GLF2125 270M□	27			30	14	1.15	5	1	
GLF2125 330M□	33			30	13	1.25	5	0.4	

□ Please specify the Inductance Tolerance Code (J, K, or M).

Note: Values from .0027μH to .039μH are available please consult factory.

Multilayer Chip Inductors - GLF3216

Part No.	Inductance (μH)	Inductance Tolerance	Q (min.)	Self Resonant frequency [MHz] (min.)	DC Resistance [Ω] (max.)	Related Current [mA] (max.)	Measuring Frequency [MHz]	Thickness [mm] (inch)
GLF3216 47NM□	0.047	±10%	20	320	0.15	300	50	0.6±0.2 (0.024±0.008)
GLF3216 68NM□	0.068	±20%	20	280	0.25	300	50	
GLF3216 R10□	0.10	±10%	20	235	0.25	250	25	
GLF3216 R12□	0.12		20	220	0.30	250	25	
GLF3216 R15□	0.15		20	200	0.30	250	25	
GLF3216 R18□	0.18		20	185	0.40	250	25	
GLF3216 R22□	0.22		20	170	0.40	250	25	
GLF3216 R27□	0.27		20	150	0.50	250	25	
GLF3216 R33□	0.33		20	145	0.60	250	25	
GLF3216 R39□	0.39		25	135	0.50	200	25	
GLF3216 R47□	0.47		25	125	0.60	200	25	
GLF3216 R56□	0.56		25	115	0.70	150	25	1.1±0.3 (0.043±0.012)
GLF3216 R68□	0.68	25	105	0.80	150	25		
GLF3216 R82□	0.82	25	100	1.90	150	25		
GLF3216 1R0□	1.0	±10%	45	75	0.40	100	10	
GLF3216 1R2□	1.2	±20%	45	65	0.50	100	10	0.6±0.2 (0.024±0.008)
GLF3216 1R5□	1.5	±10%	45	60	0.50	50	10	
GLF3216 1R8□	1.8	±10%	45	55	0.50	50	10	1.1±0.3 (0.043±0.012)
GLF3216 2R2□	2.2	±10%	45	50	0.60	50	10	
GLF3216 2R7□	2.7	±10%	45	45	0.60	50	10	
GLF3216 3R3□	3.3	±10%	45	41	0.70	50	10	
GLF3216 3R9□	3.9	±10%	45	38	0.80	50	10	
GLF3216 4R7□	4.7	±10%	45	35	0.90	50	10	
GLF3216 5R6□	5.6	±10%	50	32	0.70	25	4	
GLF3216 6R8□	6.8	±10%	50	29	0.80	25	4	
GLF3216 8R2□	8.2	±10%	50	26	0.90	25	4	
GLF3216 100□	10	±10%	50	24	1.00	25	2	
GLF3216 120□	12	±10%	50	22	1.05	15	2	
GLF3216 150M□	15	±10%	35	19	0.70	5	1	1.1±0.3 (0.043±0.012)
GLF3216 180M□	18	±10%	35	18	0.70	5	1	
GLF3216 220M□	22	±20%	35	16	0.90	5	1	
GLF3216 270M□	27	±10%	35	14	0.90	5	1	
GLF3216 330M□	33	±20%	35	13	1.05	5	0.4	

□ Please specify the Inductance Tolerance Code (K or M).

Multilayer Chip Inductors

ELECTRICAL CHARACTERISTICS

Typical DC Bias Characteristics (measured by HP4194A)

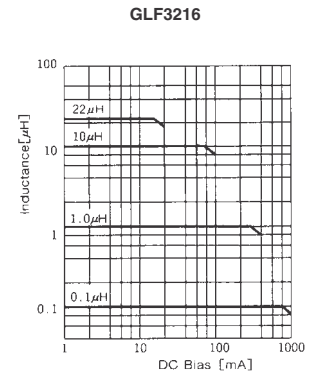
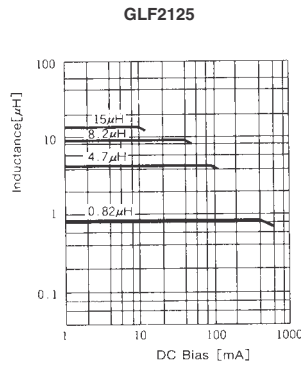
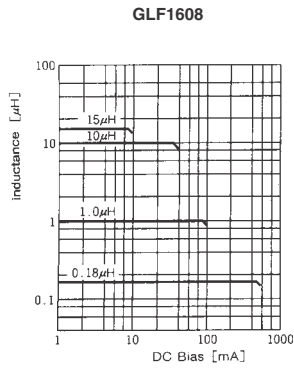

Typical Temperature Characteristics (measured by HP4275A)

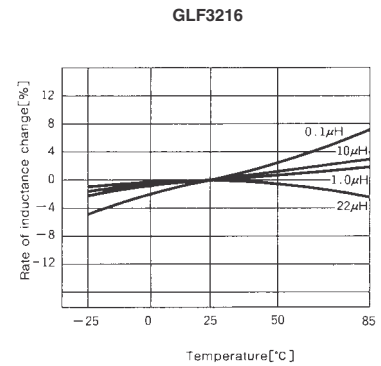
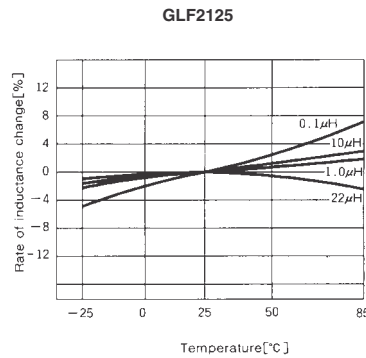
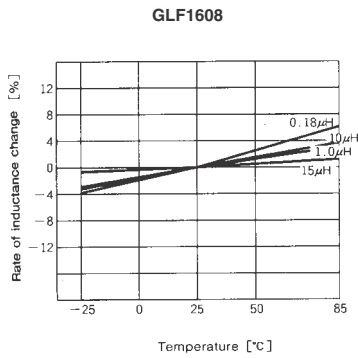

Typical Q vs Frequency Characteristics (measured by HP4195A & 41951A)

